

# MINI SATELLITE

IN-ROOM, IN-WALL



## MINI SATELLITE

IN-ROOM, IN-WALL

Triad's compact, multi-purpose Mini Sat delivers quality acoustics to intimate theater settings, two-channel music systems, and multiple household spaces. A carefully engineered two-way design blends seamlessly into its surroundings while delivering engaging, realistic audio. When joined with a subwoofer, Triad Mini Sats deliver dynamic sound, rivaling larger more imposing speakers. If your space requires discrete flexibility without compromising quality, Triad Mini Sats deliver the perfect solution.

In an industry of generic, mass-produced products, Triad combines craftsmanship and customization in every order. Handcrafted in the US using the finest materials and components, Triad's fully engineered, sealed, and internally braced MDF enclosures deliver intricate acoustics and effortless playback, actualizing the artist's intent. Use as a capable, standalone pair of speakers, or create a full-range surround sound experience by pairing with Triad LCRs and subs.

Distinguished by custom paint-matching and veneer finishes, Triad speakers achieve unobtrusive elegance while retaining the integrity of sound.

## FEATURES

- Fully engineered, premium MDF enclosure
- Acoustic suspension
- Compact, two-way design
- Custom paint matching available

### IN-ROOM

- Veneer or custom paint finishes available
- Cloth grill

### IN-WALL

- Flat design
- AcustiPerf metal grill

# MINI SATELLITE IN-ROOM AND IN-WALL

## SPECIFICATIONS

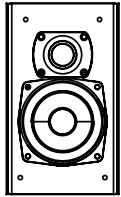

IN-ROOM

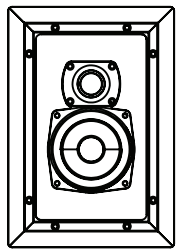

IN-WALL

### MATERIALS

Tweeter count	1
Tweeter size	1" (25 mm)
Tweeter type	Fabric dome
Woofer count	1
Woofer size	4" (11 cm)
Woofer type	Paper/fiber blend

### PERFORMANCE

Recommended amplifier power	25 - 75W
Impedance	8 ohms
Frequency response (+/- 3 dB)	100 Hz - 20 kHz

### DIMENSIONS

Cabinet specifications (L x W x D)	With grill: 8 7/8 x 5 1/4 x 5 5/16" (22.6 x 13.3 x 13.5 cm)
Hole cut out (L x W)	-
Frameless grill dimensions (L x W)	-
NCB size	-
Product weight (ea.)	5.4 lb (2.4 kg)
Shipping weight (ea.)	8 lb (3.6 kg)

### PRODUCT NUMBERS

Painted finish	21003-4000-1
Veneer finish	21003-6000-1

### IN-ROOM

### IN-ROOM

### IN-ROOM

### IN-ROOM

### IN-WALL/4

### IN-WALL/4

### IN-WALL/4

### IN-WALL/4

Product page

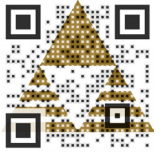

triadspkrs.co/  
minisat

## DIMENSIONS

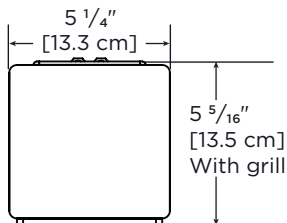

Top view

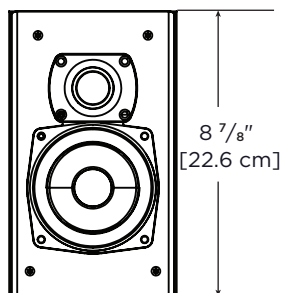

Front view

### IN-ROOM

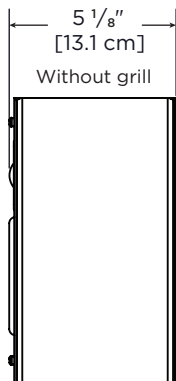

Side view (right)

### IN-WALL

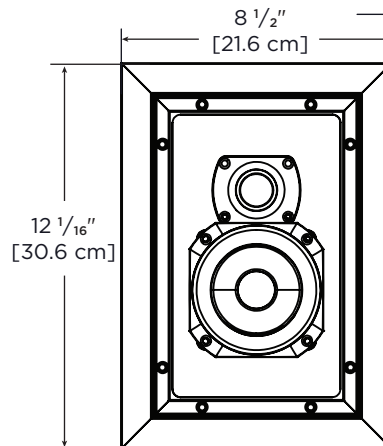

Front view

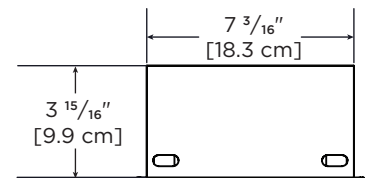

Top view

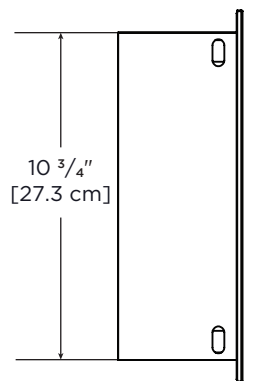

Side view